



MICROWAVE CORPORATION v02.0607



HMC318MS8G / 318MS8GE

GaAs MMIC LOW NOISE AMPLIFIER with AGC, 5.0 - 6.0 GHz

Typical Applications

The HMC318MS8G / HMC318MS8GE is ideal for:

- UNII
- HiperLAN

Features

- LNA with 18 dB Gain Control
- +3V Operation
- Low Noise Figure: 2.5 dB
- No External Components
- Ultra Small 8 Lead MSOP:
14.8mm² x 1mm High

Functional Diagram

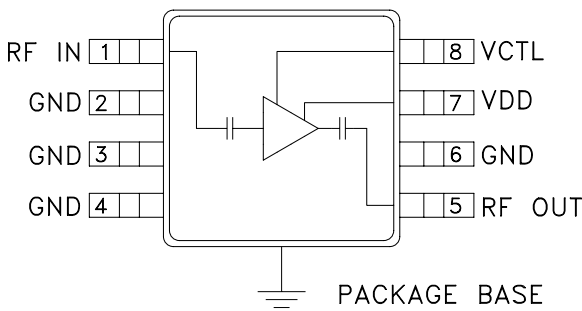

General Description

The HMC318MS8G & HMC318MS8GE are surface mount low cost C-band variable gain low noise amplifiers (VGLNA) that serve the full UNII and HiperLAN bands. The HMC318MS8G & HMC318MS8GE operate using a single positive supply that can be set between +3V or +5V. When a control voltage of 0V to +3V is applied, the gain of the amplifier will decrease while maintaining excellent return loss performance. A maximum gain of 9 dB is achieved when VCTL is set to 0V and a minimum gain of -9 dB is achieved when Vctl is set to +3V.

Electrical Specifications, $T_A = +25^\circ C$, $V_{dd} = +3V$

| Parameter* | Min. | Typ. | Max. | Units |
|--|-----------|------|------|-------|
| Frequency Range | 5.0 - 6.0 | | | GHz |
| Gain | 6 | 9 | 12 | dB |
| Gain Variation over Temperature | | 0.03 | 0.04 | dB/°C |
| Gain Control Range | 11 | 18 | 23 | dB |
| Noise Figure | | 2.5 | 4.0 | dB |
| Input Return Loss | 6 | 12 | | dB |
| Output Return Loss | 7 | 13 | | dB |
| Output Power for 1 dB Compression (P1dB) | -1 | 2 | | dBm |
| Output Third Order Intercept (OIP3) | 10 | 13 | | dBm |
| Supply Current (I _{dd}) | | 6 | 10 | mA |

* Specifications refer to the maximum gain state (Vctl = 0V) unless otherwise noted.



HMC318MS8G / 318MS8GE
GaAs MMIC LOW NOISE AMPLIFIER
with AGC, 5.0 - 6.0 GHz

Gain & Return Loss @ Vctl = 0V

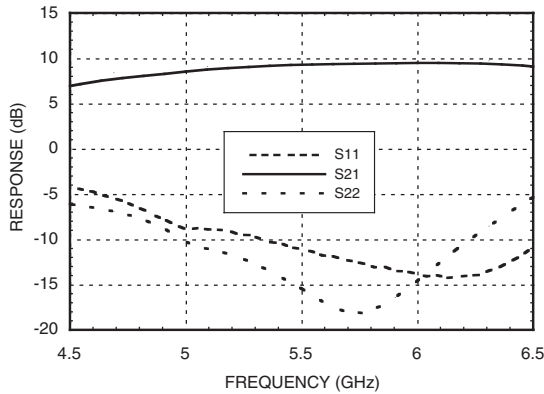

Gain over Control Range

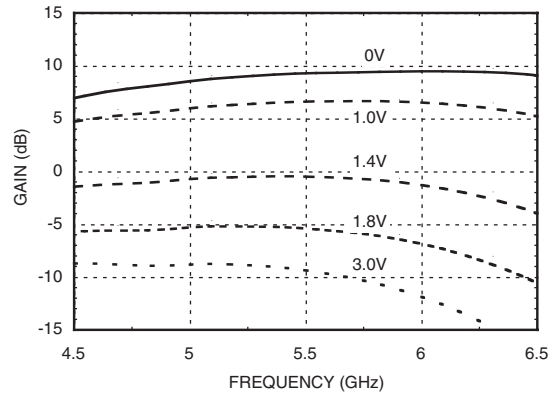

Gain vs. Temperature, Vctl = 0V

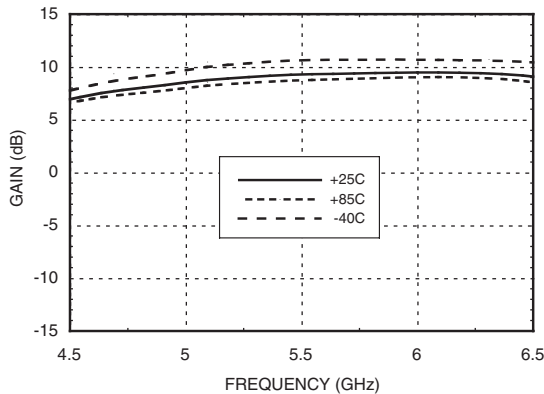

Noise Figure vs. Temperature, Vctl = 0V

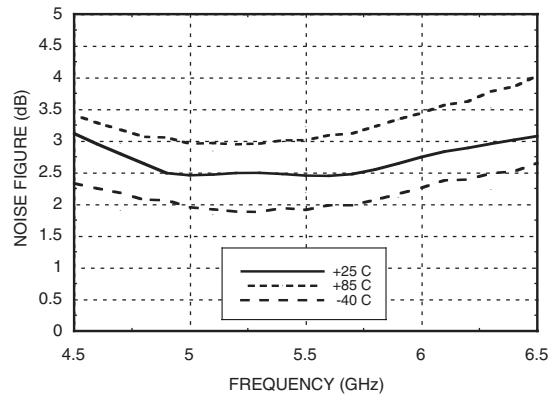

Input Return Loss vs. Temperature, Vctl = 0V

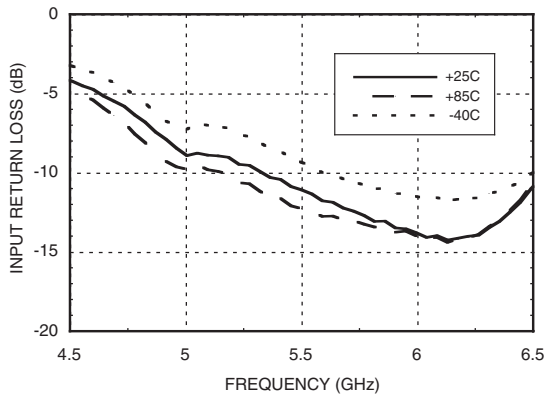

Output Return Loss vs. Temperature, Vctl = 0V

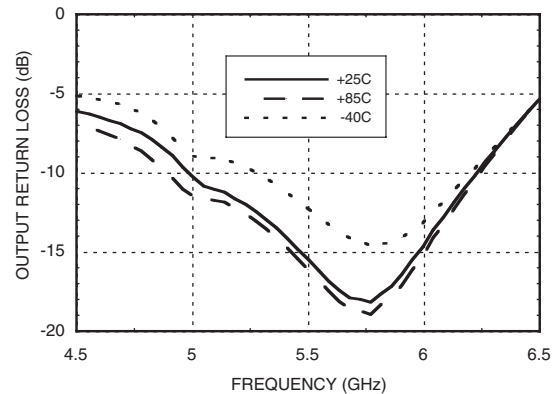



MICROWAVE CORPORATION v02.0607



HMC318MS8G / 318MS8GE

**GaAs MMIC LOW NOISE AMPLIFIER
with AGC, 5.0 - 6.0 GHz**

5 AMPLIFIERS - SMT

Gain vs. Control Voltage @ 5.8 GHz

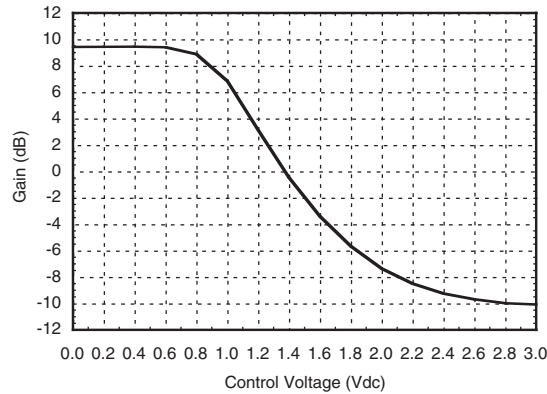

Input Return Loss over Control Range

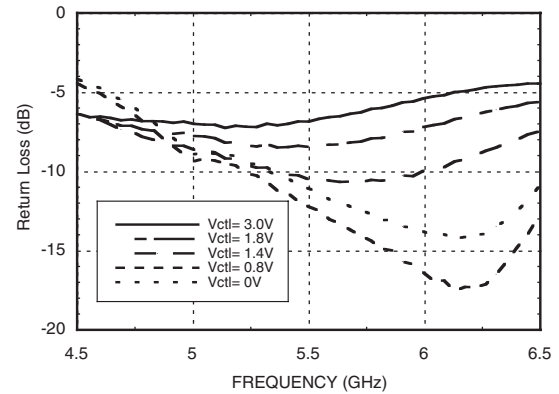

Output Return Loss over Control Range

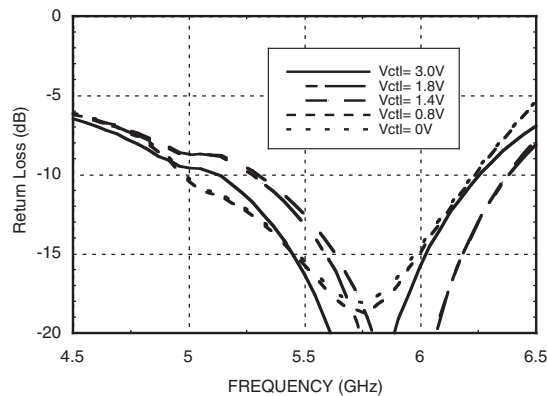

Reverse Isolation vs. Temperature, Vctl = 0V

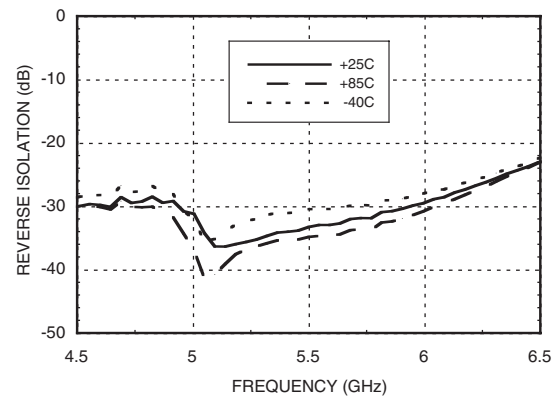

Noise Figure and OIP3 vs. Control Voltage

| Frequency = 5.8 GHz | | |
|---------------------|-------------------|-------------|
| VCTL | Noise Figure (dB) | OIP3 (dBm)* |
| 0V | 2.5 | 13.0 |
| 1.4V | 4.5 | 1.2 |
| 3.0V | 10.5 | -6.7 |

*Two-tone input power = -20 dBm per tone.

Absolute Maximum Ratings

| | |
|---|----------------|
| Drain Bias Voltage (Vdd) | +7.0 Vdc |
| Control Voltage Range (Vctl) | -0.2 to Vdd |
| RF Input Power (RFIn)(Vdd = +3.0 Vdc) | 0 dBm |
| Channel Temperature | 150 °C |
| Continuous Pdiss (T = 85 °C) (derate 9.76 mW/°C above 85 °C) | 0.634 W |
| Thermal Resistance (channel to ground paddle) | 102 °C/W |
| Storage Temperature | -65 to +150 °C |
| Operating Temperature | -40 to +85 °C |
| ESD Sensitivity (HBM) | Class 1A |

Gain Control

| Vctl (Vdc) | Gain State | Typical Ictl (uA) |
|------------|------------|-------------------|
| 0 | Maximum | 25 |
| Vdd | Minimum | 25 |



**ELECTROSTATIC SENSITIVE DEVICE
OBSERVE HANDLING PRECAUTIONS**

For price, delivery, and to place orders, please contact Hittite Microwave Corporation:
20 Alpha Road, Chelmsford, MA 01824 Phone: 978-250-3343 Fax: 978-250-3373
Order On-line at www.hittite.com

HMC318MS8G / 318MS8GE

GaAs MMIC LOW NOISE AMPLIFIER with AGC, 5.0 - 6.0 GHz

Outline Drawing

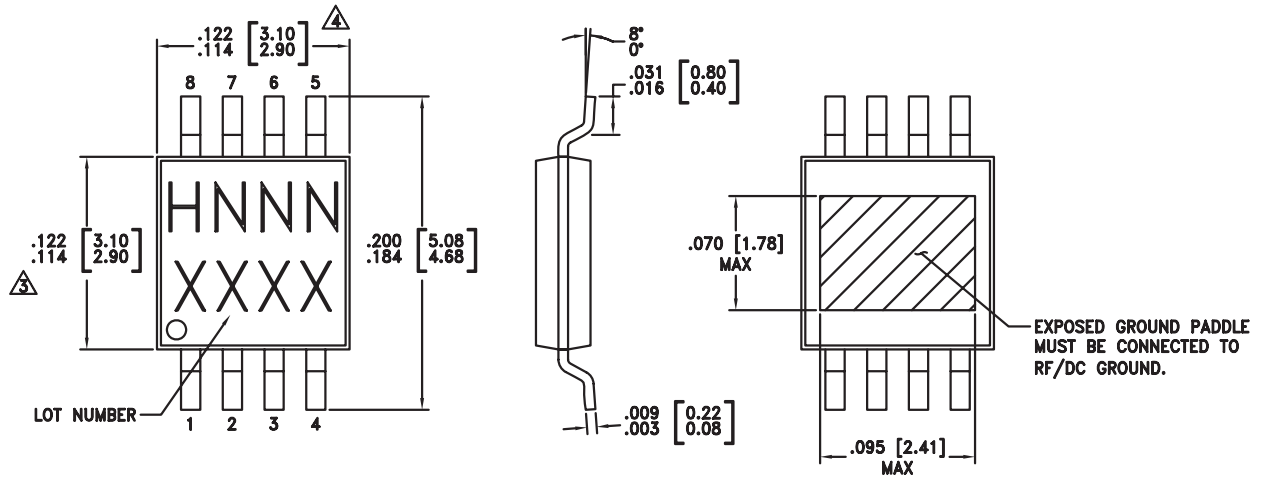

NOTES:

1. LEADFRAME MATERIAL: COPPER ALLOY
2. DIMENSIONS ARE IN INCHES [MILLIMETERS].
- △ DIMENSION DOES NOT INCLUDE MOLDFLASH OF 0.15mm PER SIDE.
- △ DIMENSION DOES NOT INCLUDE MOLDFLASH OF 0.25mm PER SIDE.
5. ALL GROUND LEADS AND GROUND PADDLE MUST BE SOLDERED TO PCB RF GROUND.

Package Information

| Part Number | Package Body Material | Lead Finish | MSL Rating | Package Marking ^[3] |
|-------------|--|---------------|---------------------|--------------------------------|
| HMC318MS8G | Low Stress Injection Molded Plastic | Sn/Pb Solder | MSL1 ^[1] | H318 XXXX |
| HMC318MS8GE | RoHS-compliant Low Stress Injection Molded Plastic | 100% matte Sn | MSL1 ^[2] | H318 XXXX |

[1] Max peak reflow temperature of 235 °C
 [2] Max peak reflow temperature of 260 °C
 [3] 4-Digit lot number XXXX

Evaluation PCB

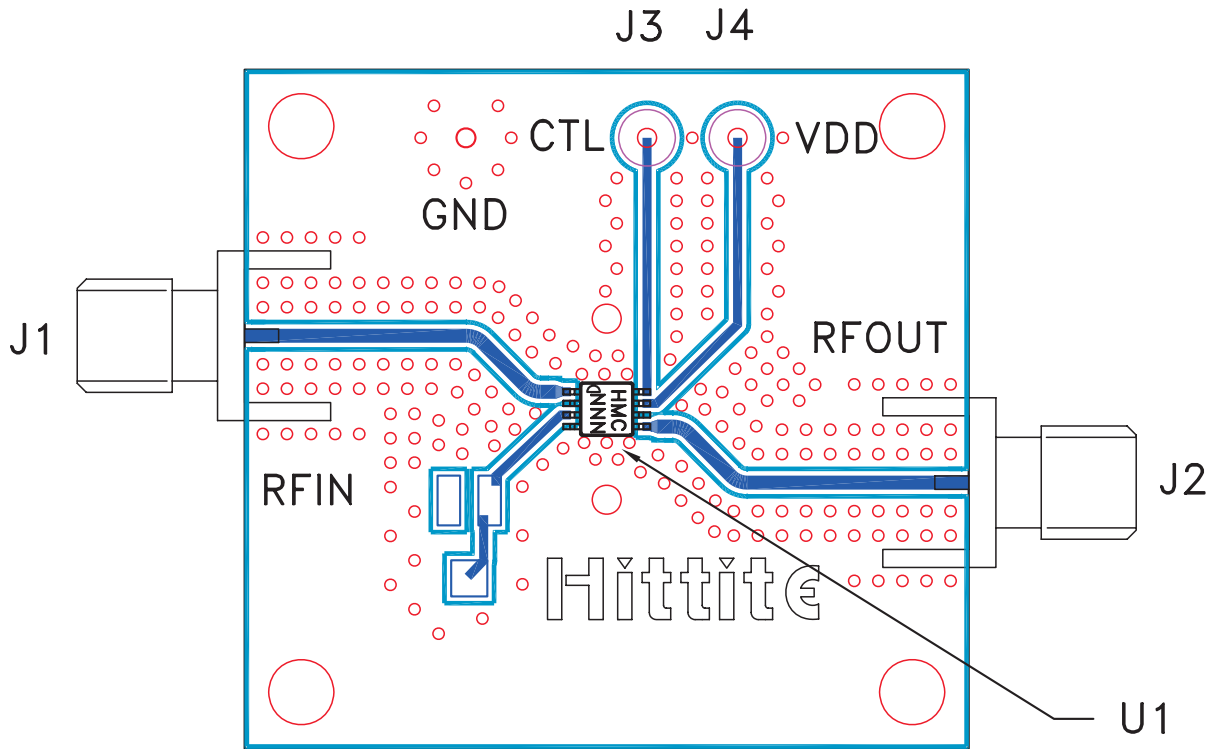

List of Materials for Evaluation PCB 104085 [1]

| Item | Description |
|---------|------------------------------------|
| J1, J2 | PCB Mount SMA Connector |
| J3, J4 | DC Pin |
| U1 | HMC318MS8G / HMC318MS8GE Amplifier |
| PCB [2] | Evaluation PCB 1.6" x 1.5" |

[1] Reference this number when ordering complete evaluation PCB

[2] Circuit Board Material: Rogers 4350

The circuit board used in the final application should use RF circuit design techniques. Signal lines should have 50 ohm impedance while the package ground leads and exposed paddle should be connected directly to the ground plane similar to that shown. A sufficient number of via holes should be used to connect the top and bottom ground planes. The evaluation circuit board shown is available from Hittite upon request.



MICROWAVE CORPORATION v02.0607



HMC318MS8G / 318MS8GE

GaAs MMIC LOW NOISE AMPLIFIER
with AGC, 5.0 - 6.0 GHz

Notes: